



600V Super-Junction Power MOSFET

FEATURES

- Very low FOM $R_{DS(on)} \times Q_g$
- 100% avalanche tested
- RoHS compliant
- Fast Body Diode

APPLICATIONS

- Switch Mode Power Supply (SMPS)
- Uninterruptible Power Supply (UPS)
- Power Factor Correction (PFC)

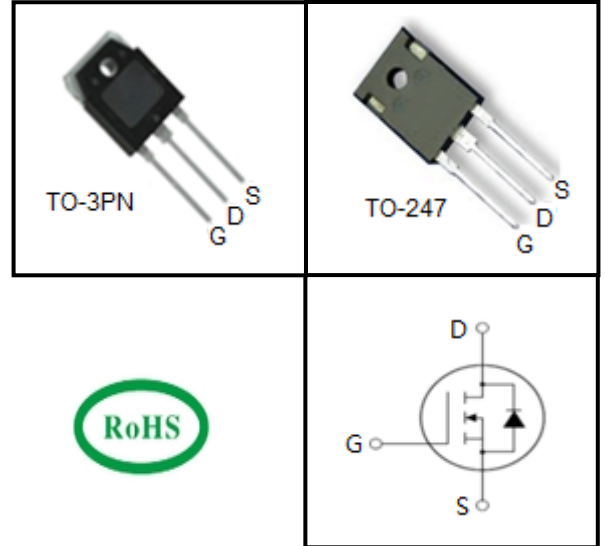

Device Marking and Package Information		
Device	Package	Marking
TPV60R080CFD	TO-3PN	60R080CFD
TPW60R080CFD	TO-247	60R080CFD

Absolute Maximum Ratings $T_C = 25^\circ\text{C}$, unless otherwise noted			
Parameter	Symbol	Value	Unit
Drain-Source Voltage ($V_{GS} = 0\text{V}$)	V_{DSS}	600	V
Continuous Drain Current	I_D	47	A
Pulsed Drain Current (note1)	I_{DM}	141	A
Gate-Source Voltage	V_{GSS}	± 30	V
Single Pulse Avalanche Energy (note2)	E_{AS}	1120	mJ
Avalanche Current (note1)	I_{AR}	15	A
Repetitive Avalanche Energy (note1)	E_{AR}	1.76	mJ
Power Dissipation ($T_C = 25^\circ\text{C}$)	P_D	390	W
Operating Junction and Storage Temperature Range	T_J, T_{stg}	-55~+150	$^\circ\text{C}$

Thermal Resistance			
Parameter	Symbol	Value	Unit
Thermal Resistance, Junction-to-Case	R_{thJC}	0.32	K/W
Thermal Resistance, Junction-to-Ambient	R_{thJA}	62	



Specifications $T_J = 25^\circ\text{C}$, unless otherwise noted						
Parameter	Symbol	Test Conditions	Value			Unit
			Min.	Typ.	Max.	
Static						
Drain-Source Breakdown Voltage	$V_{(BR)DSS}$	$V_{GS} = 0V, I_D = 250\mu\text{A}$	600	--	--	V
Zero Gate Voltage Drain Current	I_{DSS}	$V_{DS} = 600V, V_{GS} = 0V, T_J = 25^\circ\text{C}$	--	--	5	μA
		$V_{DS} = 600V, V_{GS} = 0V, T_J = 150^\circ\text{C}$	--	--	5000	
Gate-Source Leakage	I_{GSS}	$V_{GS} = \pm 30V$	--	--	± 100	nA
Gate-Source Threshold Voltage	$V_{GS(th)}$	$V_{DS} = V_{GS}, I_D = 250\mu\text{A}$	2.5	--	4.5	V
Drain-Source On-Resistance (Note3)	$R_{DS(on)}$	$V_{GS} = 10V, I_D = 20A$	--	65	80	m Ω
Forward Transconductance (Note3)	g_{fs}	$V_{DS} = 10V, I_D = 20A$	--	40	--	S
Dynamic						
Input Capacitance	C_{iss}	$V_{GS} = 0V,$ $V_{DS} = 50V,$ $f = 1.0\text{MHz}$	--	5100	--	pF
Output Capacitance	C_{oss}		--	225	--	
Reverse Transfer Capacitance	C_{rss}		--	6.2	--	
Total Gate Charge	Q_g	$V_{DD} = 480V, I_D = 47A,$ $V_{GS} = 10V$	--	90	--	nC
Gate-Source Charge	Q_{gs}		--	24	--	
Gate-Drain Charge	Q_{gd}		--	30	--	
Turn-on Delay Time	$t_{d(on)}$	$V_{DD} = 400V, I_D = 26A,$ $R_G = 1.7\Omega$	--	16	--	ns
Turn-on Rise Time	t_r		--	12	--	
Turn-off Delay Time	$t_{d(off)}$		--	83	--	
Turn-off Fall Time	t_f		--	5	--	
Drain-Source Body Diode Characteristics						
Continuous Body Diode Current	I_S	$T_C = 25^\circ\text{C}$	--	--	47	A
Pulsed Diode Forward Current	I_{SM}		--	--	141	
Body Diode Voltage	V_{SD}	$T_J = 25^\circ\text{C}, I_{SD} = 47A, V_{GS} = 0V$	--	0.9	1.2	V
Reverse Recovery Time	t_{rr}	$V_R = 400V, I_F = 26A,$ $di_F/dt = 100\text{A}/\mu\text{s}$	--	180	--	ns
Reverse Recovery Charge	Q_{rr}		--	1	--	μC
Peak Reverse Recovery Current	I_{rrm}		--	10	--	A

Notes

1. Repetitive Rating: Pulse Width limited by maximum junction temperature
2. $I_{AS} = 15A, V_{DD} = 50V, R_G = 25\Omega$, Starting $T_J = 25^\circ\text{C}$
3. Pulse Test: Pulse Width $\leq 300\mu\text{s}$, Duty Cycle $\leq 1\%$



Typical Characteristics $T_J = 25^\circ\text{C}$, unless otherwise noted

Figure 1. Output Characteristics

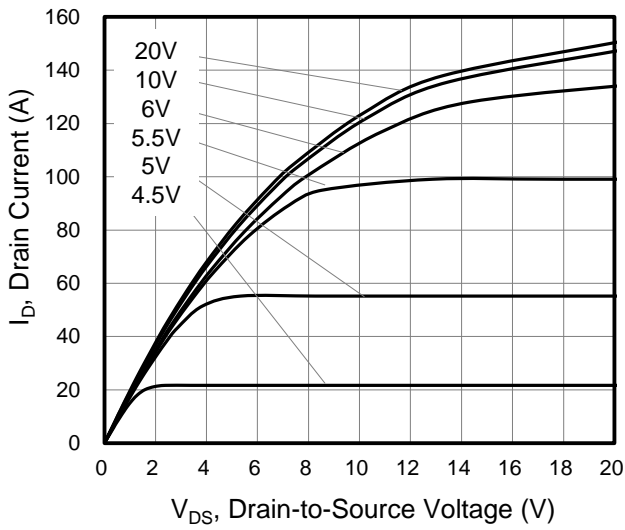

Figure 2. Transfer Characteristics

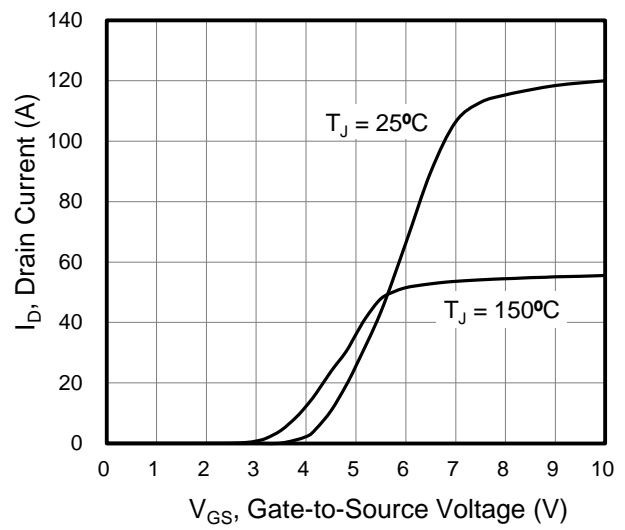

Figure 3. On-Resistance vs. Drain Current

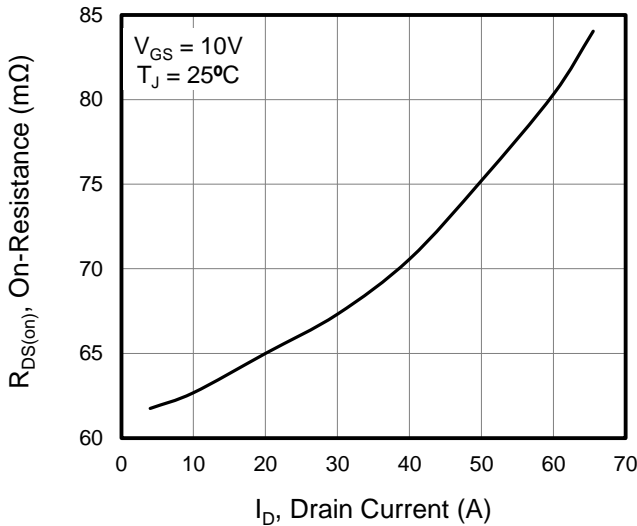

Figure 4. Capacitance

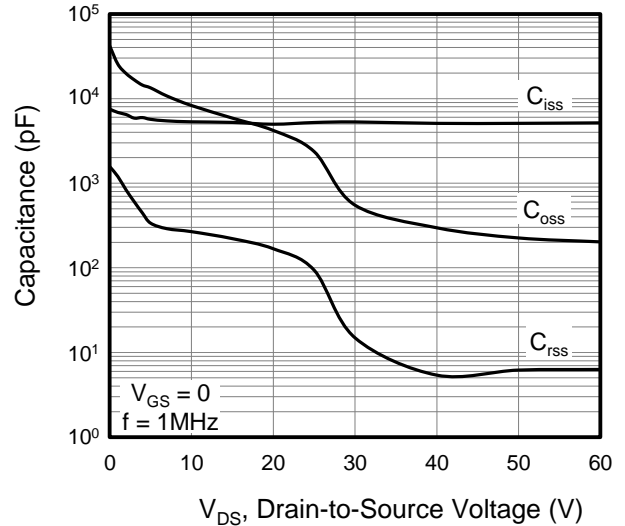

Figure 5. Gate Charge

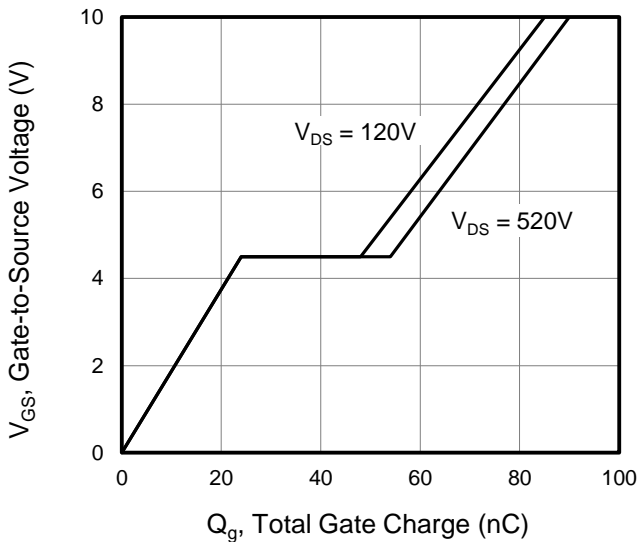
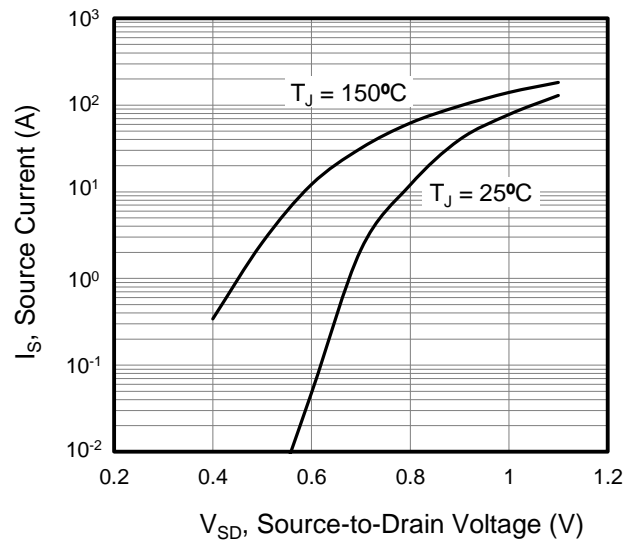

Figure 6. Body Diode Forward Voltage





Typical Characteristics $T_J = 25^\circ\text{C}$, unless otherwise noted

Figure 7. On-Resistance vs. Temperature

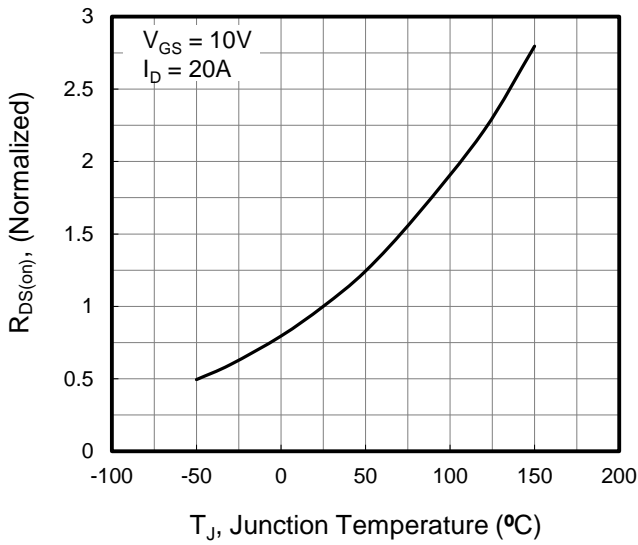

Figure 8. Threshold Voltage vs. Temperature

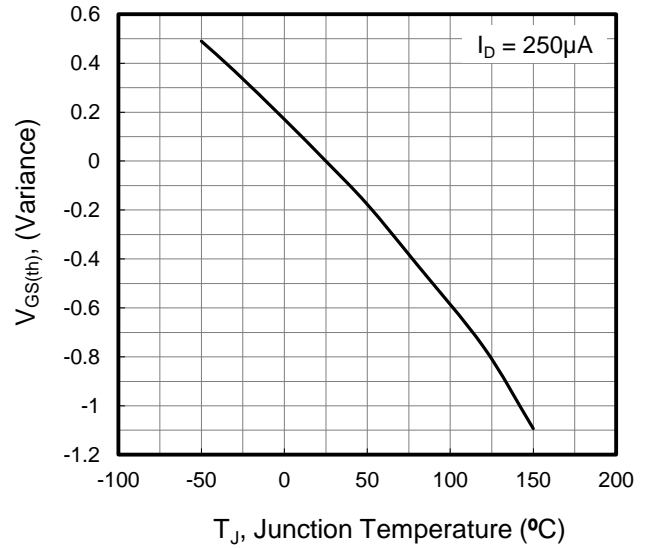

Figure 9. Transient Thermal Impedance

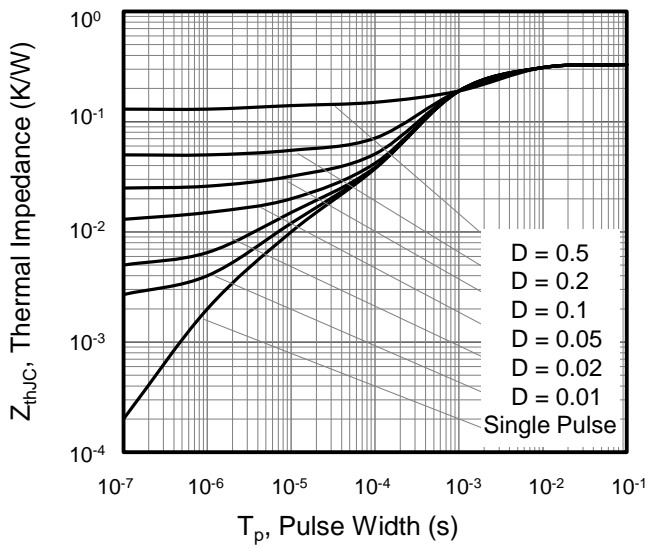



Figure A: Gate Charge Test Circuit and Waveform

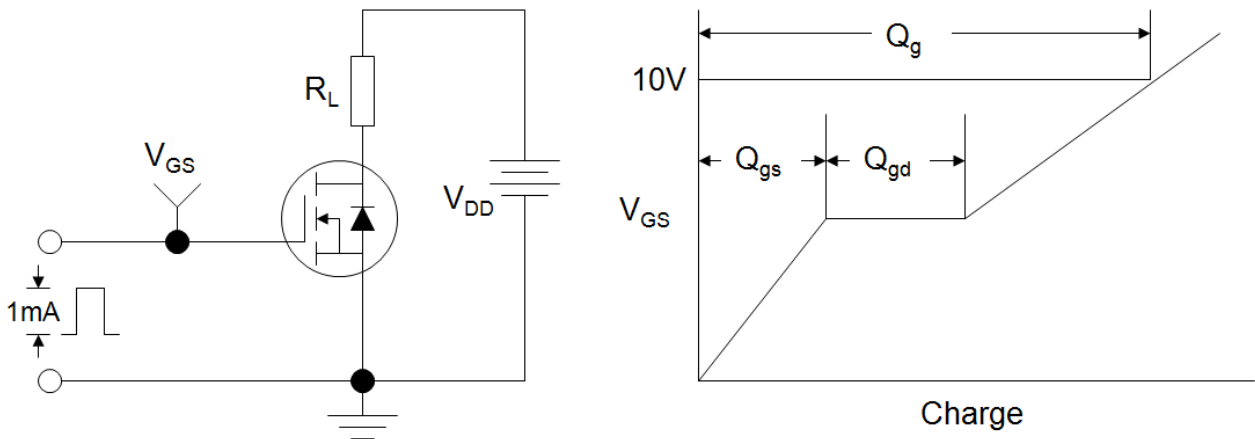

Figure B: Resistive Switching Test Circuit and Waveform

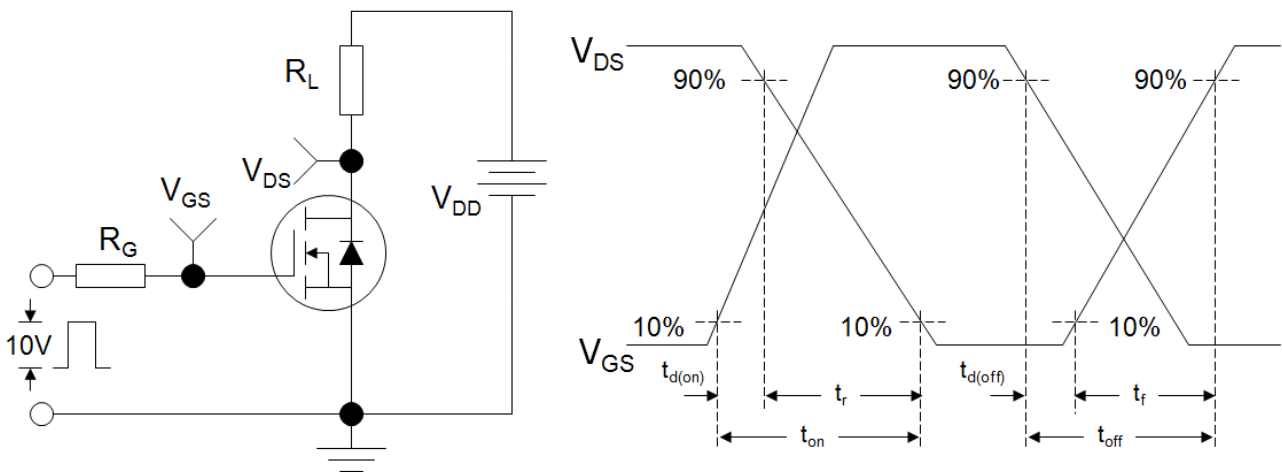
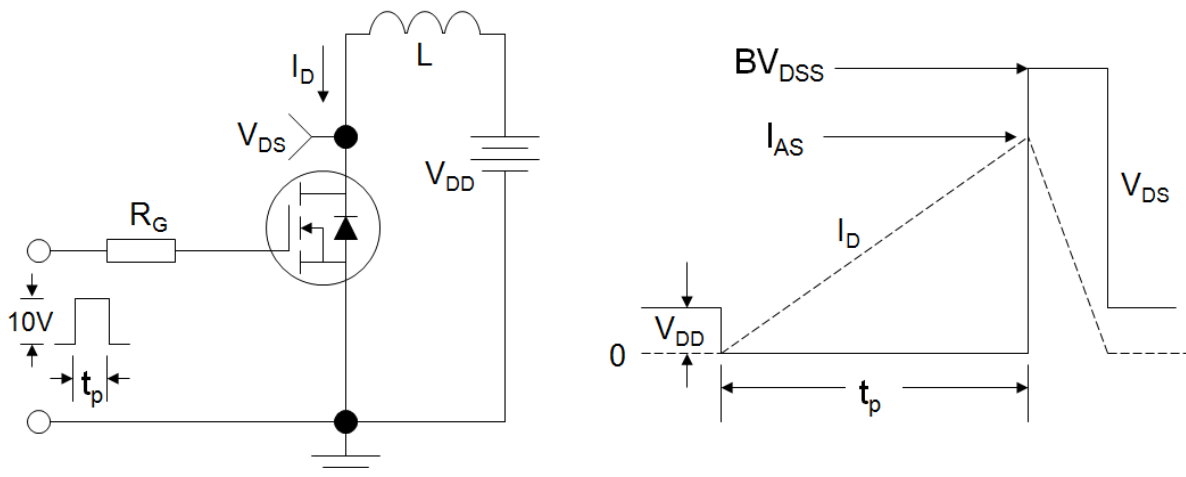
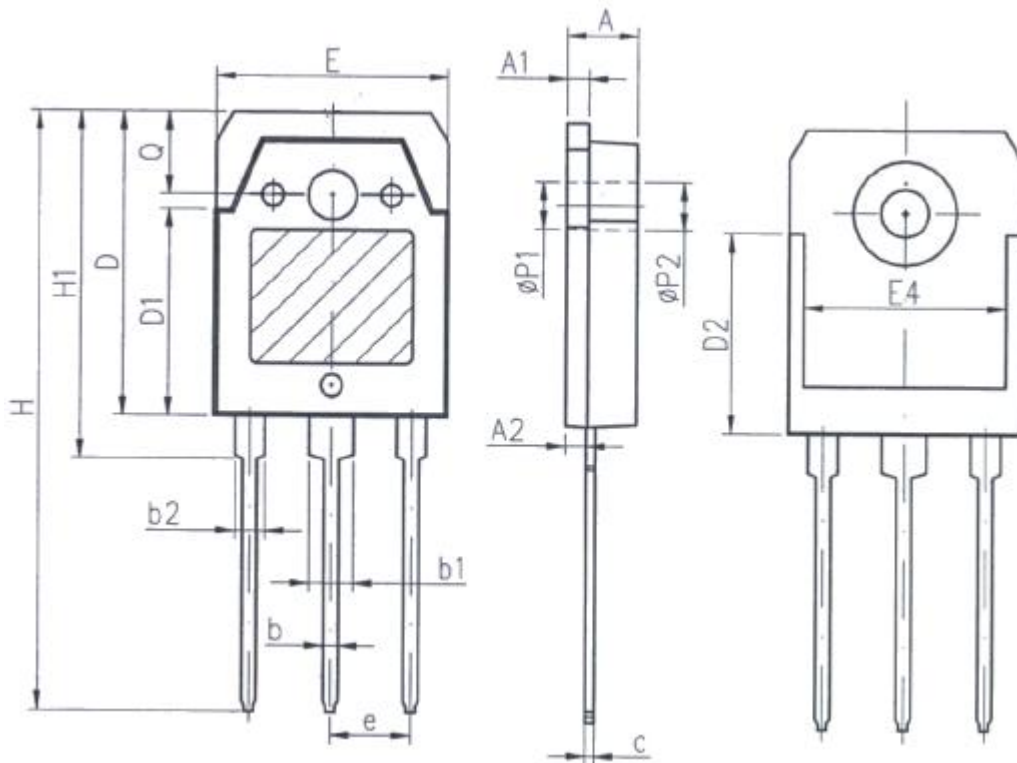

Figure C: Unclamped Inductive Switching Test Circuit and Waveform





TO-3PN



Unit:mm		
Symbol	Min.	Max.
A	4.6	5
A1	1.4	1.65
A2	1.18	1.58
b	0.8	1.2
b1	2.8	3.2
b2	1.8	2.2
c	0.5	0.75
D	19.6	20.2
D1	13.55	14.25
D2	12.9REF	
E	15.35	15.85
E4	12.6	-
e	5.45TYP	
H	40.1	40.9
H1	23.15	23.65
P1	3.2REF	
P2	3.5REF	



TO-247

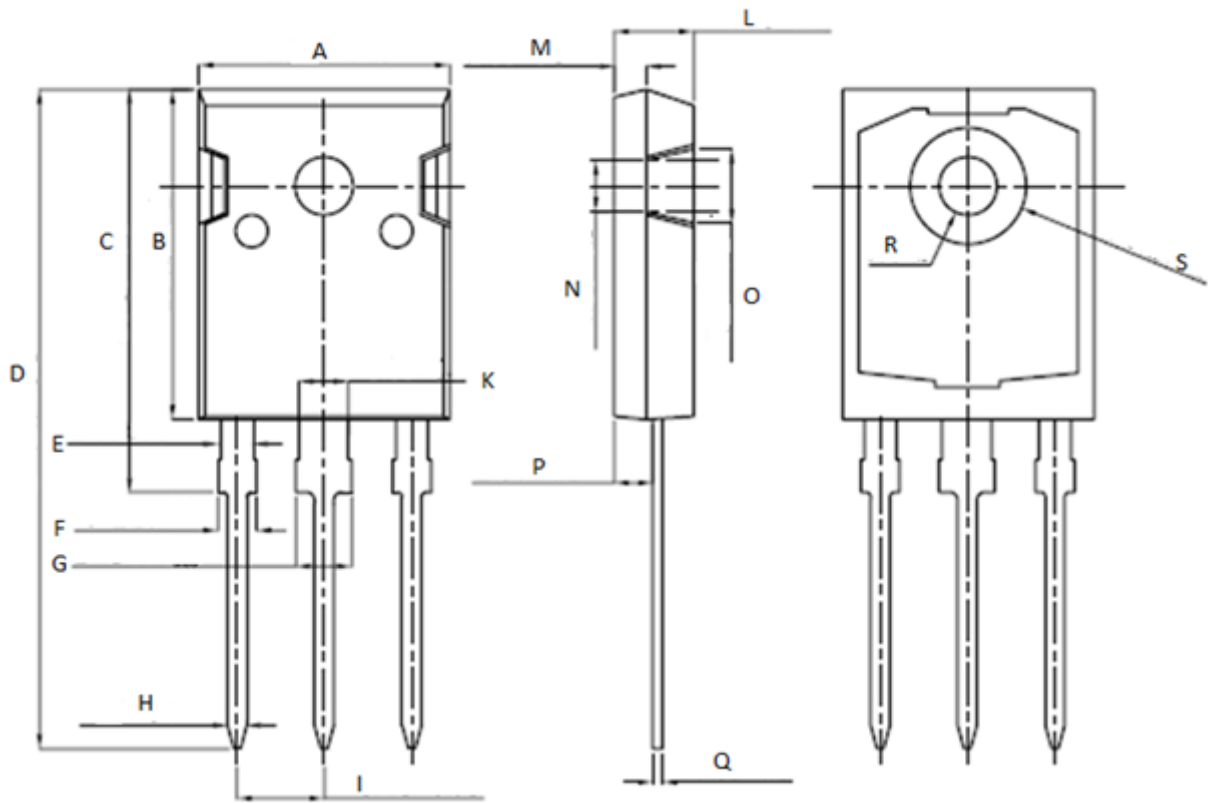

Unit: mm		
Symbol	Min.	Max.
A	15.95	16.25
B	20.85	21.25
C	20.95	21.35
D	40.5	40.9
E	1.9	2.1
F	2.1	2.25
G	3.1	3.25
H	1.1	1.3
I	5.40	5.50

Unit: mm		
Symbol	Min.	Max.
K	2.90	3.10
L	4.90	5.30
M	1.90	2.10
N	4.50	4.70
O	5.40	5.60
P	2.29	2.49
Q	0.51	0.71
R	ϕ 3.5	ϕ 3.7
S	ϕ 7.1	ϕ 7.3



Disclaimer

All product specifications and data are subject to change without notice.

For documents and material available from this datasheet, Wuxi Unigroup does not warrant or assume any legal liability or responsibility for the accuracy, completeness of any product or technology disclosed hereunder.

No license, express or implied, by estoppels or otherwise, to any intellectual property rights is granted by this document or by any conduct of Wuxi Unigroup.

The products shown herein are not designed for use in medical, life-saving, or life-sustaining applications. Customers using or selling Wuxi Unigroup products not expressly indicated for use in such applications do so entirely at their own risk and agree to fully indemnify Wuxi Unigroup for any damages arising or resulting from such use or sale.

Wuxi Unigroup disclaims any and all liability arising out of the use or application of any product described herein or of any information provided herein to the maximum extent permitted by law. The product specifications do not expand or otherwise modify Wuxi Unigroup's terms and conditions of purchase, including but not limited to the warranty expressed therein, which apply to these products.

Wuxi Unigroup Microelectronics CO., LTD. strives to supply high-quality high-reliability products. However, any and all semiconductor products fail with some probability. It is possible that these probabilistic failures could give rise to accidents or events that could endanger human lives that could give rise to smoke or fire, or that could cause damage to other property. When designing equipment, adopt safety measures so that these kinds of accidents or events cannot occur. Such measures include but are not limited to protective circuits and error prevention circuits for safe design, redundant design, and structural design.

In the event that any or all Wuxi Unigroup products (including technical data, services) described or contained herein are controlled under any of applicable local export control laws and regulations, such products must not be exported without obtaining the export license from the authorities concerned in accordance with the above law.

Information (including circuit diagrams and circuit parameters) herein is for example only. It is not guaranteed for volume production. Wuxi Unigroup believes information herein is accurate and reliable, but no guarantees are made or implied regarding its use or any infringements of intellectual property rights or other rights of third parties.