



700V Super-junction Power MOSFET

Description

700V Super-junction Power MOSFET

Super-junction power MOSFET is a revolutionary technology for high voltage power MOSFETs, designed according to the SJ principle and pioneered. The Multi-EPI SJ MOSFET provide an extremely fast and robust body diode. Also provide an extremely low switching, communication and conduction losses device with highest robustness make especially resonant switching applications more reliable, more efficient, lighter and cooler, designed by Wuxi Unigroup Microelectronics Company.

Features

- Ultra-fast body diode
- Very low FOM $R_{DS(on)} \times Q_g$
- Easy to use/drive
- 100% avalanche tested
- RoHS compliant

Applications

- Switch Mode Power Supply (SMPS)
- Uninterruptible Power Supply (UPS)
- Power Factor Correction (PFC)
- LLC Half-bridge
- Charger

TO-220F



TO-247

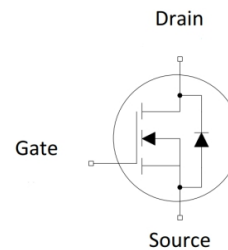

Device Marking and Package Information

Device	Package	Marking
TPA70R300MFD	TO-220F	70R300MFD
TPW70R300MFD	TO-247	70R300MFD

Key Performance Parameters

Parameter	Value	Unit
$V_{DS} @ T_{j,max}$	750	V
$R_{DS(on),max}$	0.30	Ω
$Q_{g,typ}$	29	nC
I_D	15	A
$I_{D,pulse}$	45	A
$E_{OSS} @ 400V$	3.23	μJ
Body Diode di_f/dt	500	A/ μs
t_{rr}	152	ns
Q_{rr}	0.84	μC
I_{rrm}	11	A



Absolute Maximum Ratings $T_C = 25^\circ\text{C}$, unless otherwise noted				
Parameter		Symbol	Value	Unit
Continuous Drain Current	$T_C = 25^\circ\text{C}$	I_D	15	A
	$T_C = 100^\circ\text{C}$		9	
Pulsed Drain Current	(note1)	$I_{D,pulse}$	45	A
Gate-Source Voltage		V_{GSS}	± 30	V
Single Pulse Avalanche Energy	(note2)	E_{AS}	290	mJ
Repetitive Avalanche Energy	(note2)	E_{AR}	0.44	mJ
Avalanche Current		I_{AR}	2.4	A
MOSFET dv/dt Ruggedness, $V_{DS} = 0 \dots 480\text{V}$		dv/dt	50	V/ns
Power Dissipation For TO-220F		P_D	32	W
Power Dissipation For TO-247			105	
Continuous Diode Forward Current		I_S	15	A
Diode Pulsed Current	(note1)	$I_{S,pulse}$	45	
Reverse Diode dv/dt	(note3)	dv/dt	15	V/ns
Maximum Diode Commutation Speed	(note3)	di_f/dt	500	A/ μs
Operating Junction and Storage Temperature Range		T_J, T_{stg}	-55~+150	$^\circ\text{C}$

Thermal Resistance For TO-220F				
Parameter		Symbol	Value	Unit
Thermal Resistance, Junction-to-Case		R_{thJC}	3.9	$^\circ\text{C}/\text{W}$
Thermal Resistance, Junction-to-Ambient		R_{thJA}	80	

Thermal Resistance For TO-247				
Parameter		Symbol	Value	Unit
Thermal Resistance, Junction-to-Case		R_{thJC}	1.2	$^\circ\text{C}/\text{W}$
Thermal Resistance, Junction-to-Ambient		R_{thJA}	62	



Electrical Characteristics $T_J = 25^\circ\text{C}$, unless otherwise noted						
Parameter	Symbol	Test Conditions	Value			Unit
			Min.	Typ.	Max.	
Static Characteristics						
Drain-Source Breakdown Voltage	$V_{(BR)DSS}$	$V_{GS} = 0V, I_D = 250\mu A$	700	--	--	V
Zero Gate Voltage Drain Current	I_{DSS}	$V_{DS} = 700V, V_{GS} = 0V, T_J = 25^\circ\text{C}$	--	--	1.75	μA
		$V_{DS} = 700V, V_{GS} = 0V, T_J = 150^\circ\text{C}$	--	--	1750	
Gate-Source Leakage Current	I_{GSS}	$V_{GS} = \pm 30V$	--	--	± 100	nA
Gate-Source Threshold Voltage	$V_{GS(th)}$	$V_{DS} = V_{GS}, I_D = 250\mu A$	3	--	5	V
Drain-Source On-State-Resistance	$R_{DS(on)}$	$V_{GS} = 10V, I_D = 7.5A$	--	0.26	0.30	Ω
Gate Resistance	R_G	$f = 1.0\text{MHz}$ open drain	--	12.5	--	Ω
Dynamic Characteristics						
Input Capacitance	C_{iss}	$V_{GS} = 0V,$ $V_{DS} = 100V,$ $f = 1.0\text{MHz}$	--	1205	--	μF
Output Capacitance	C_{oss}		--	45	--	
Reverse Transfer Capacitance	C_{rss}		--	3	--	
Total Gate Charge	Q_g	$V_{DD} = 560V, I_D = 15A,$ $V_{GS} = 10V$	--	29	--	nC
Gate-Source Charge	Q_{gs}		--	8	--	
Gate-Drain Charge	Q_{gd}		--	11	--	
Turn-on Delay Time	$t_{d(on)}$	$V_{DD} = 400V, I_D = 15A,$ $R_G = 25\Omega$	--	24	--	ns
Turn-on Rise Time	t_r		--	31	--	
Turn-off Delay Time	$t_{d(off)}$		--	121	--	
Turn-off Fall Time	t_f		--	40	--	
Drain-Source Body Diode Characteristics						
Body Diode Forward Voltage	V_{SD}	$T_J = 25^\circ\text{C}, I_{SD} = 7.5A, V_{GS} = 0V$	--	1.0	1.5	V
Reverse Recovery Time	t_{rr}	$V_R = 400V, I_F = I_S,$ $di_F/dt = 100A/\mu s$	--	152	--	ns
Reverse Recovery Charge	Q_{rr}		--	0.84	--	μC
Peak Reverse Recovery Current	I_{rrm}		--	11	--	A

Notes

1. Repetitive Rating: Pulse width limited by maximum junction temperature
2. $I_{AS} = 2.4A, V_{DD} = 50V, R_G = 25\Omega,$ Starting $T_J = 25^\circ\text{C}$
3. Identical low side and high side switch with identical R_G



Typical Characteristics $T_J = 25^\circ\text{C}$, unless otherwise noted

Figure 1. Output Characteristics

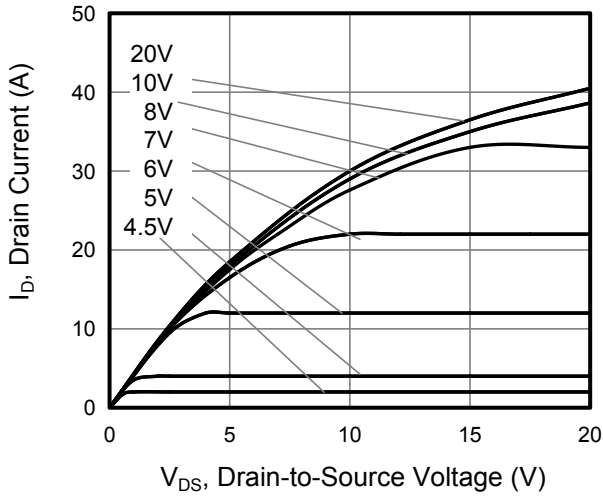

Figure 2. Transfer Characteristics

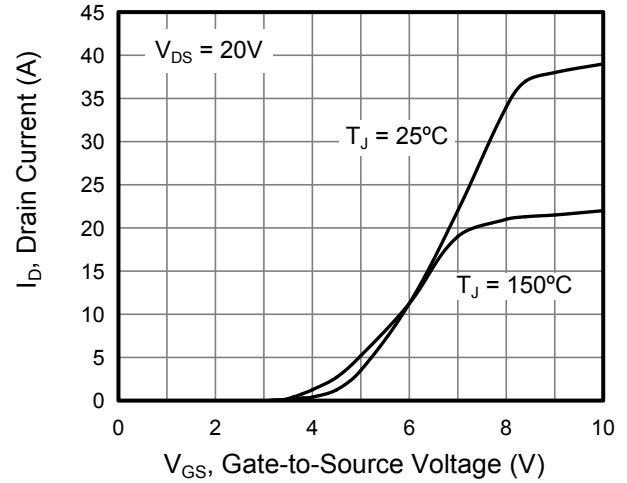

Figure 3. On-Resistance vs. Drain Current

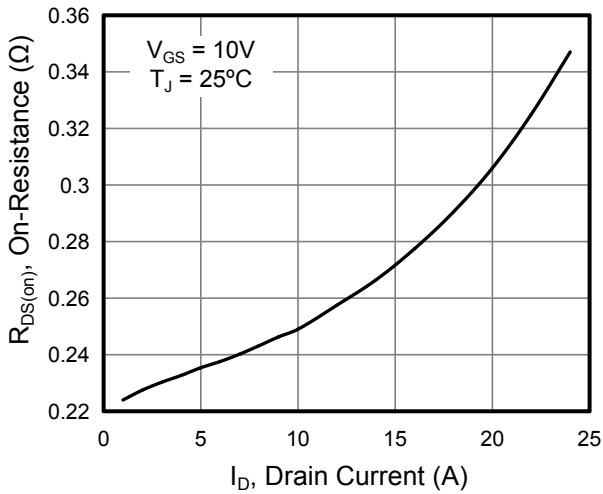

Figure 4. Capacitance

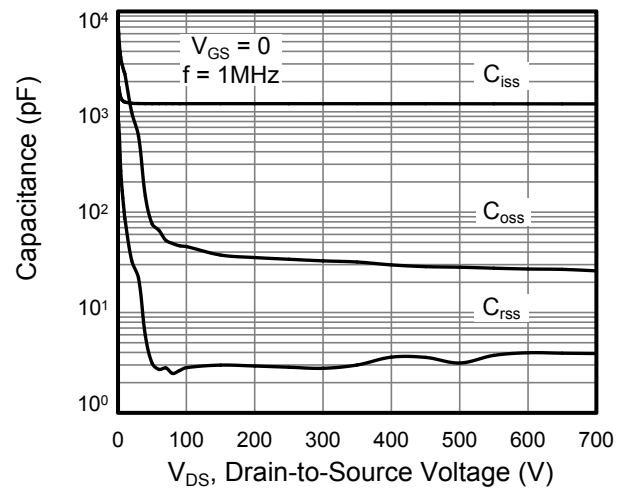

Figure 5. Gate Charge

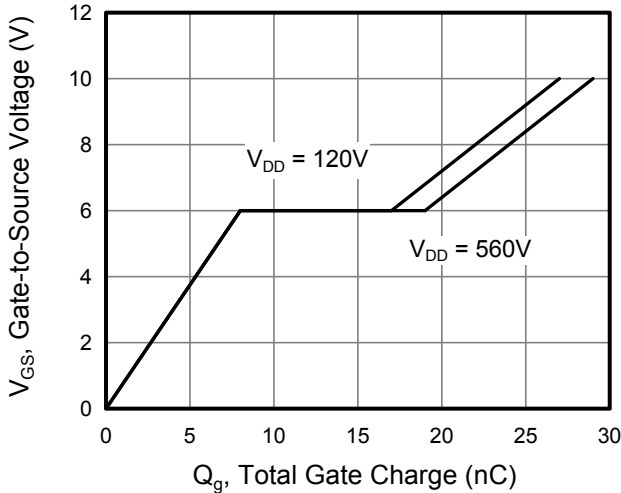
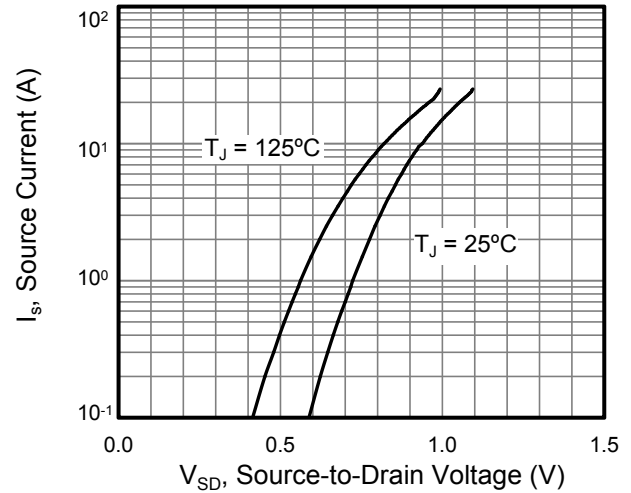

Figure 6. Body Diode Forward Voltage





Typical Characteristics $T_J = 25^\circ\text{C}$, unless otherwise noted

Figure 7. On-Resistance vs. Junction Temperature

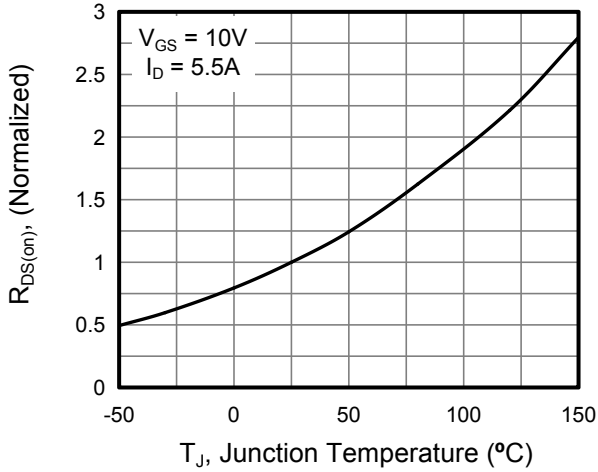

Figure 8. Breakdown voltage vs. Junction Temperature

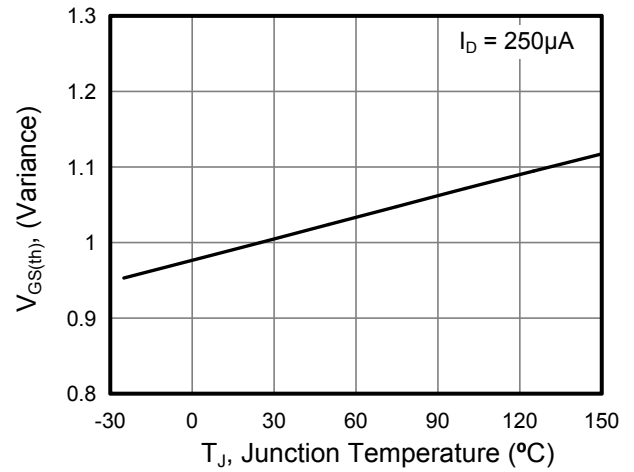

Figure 9. Transient Thermal Impedance For TO-220F

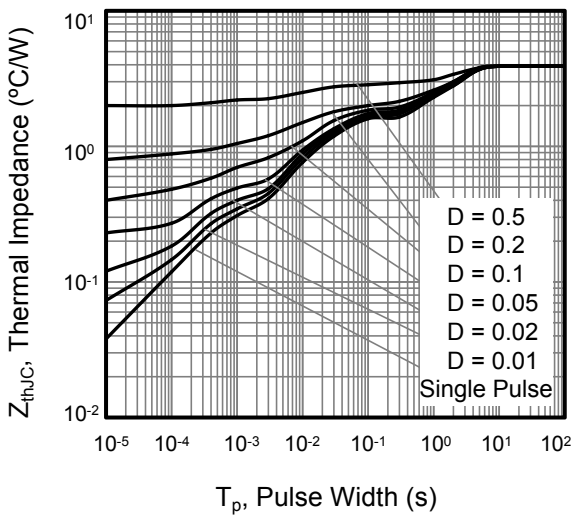

Figure 10. Transient Thermal Impedance For TO-247

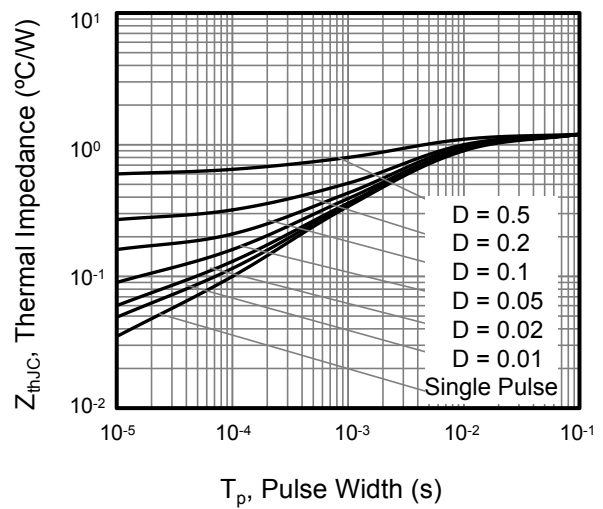

Figure 11. Safe Operation Area For TO-220F

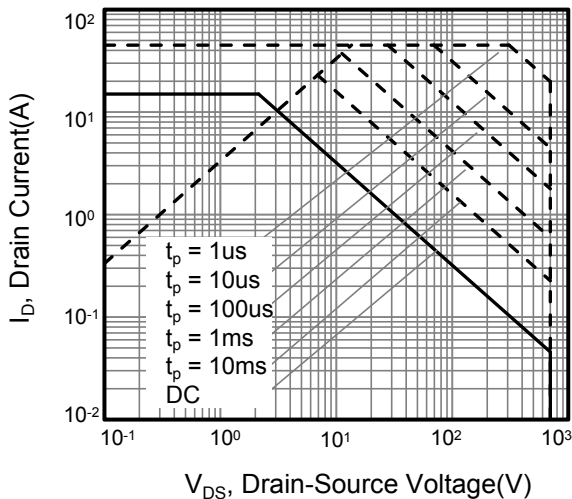
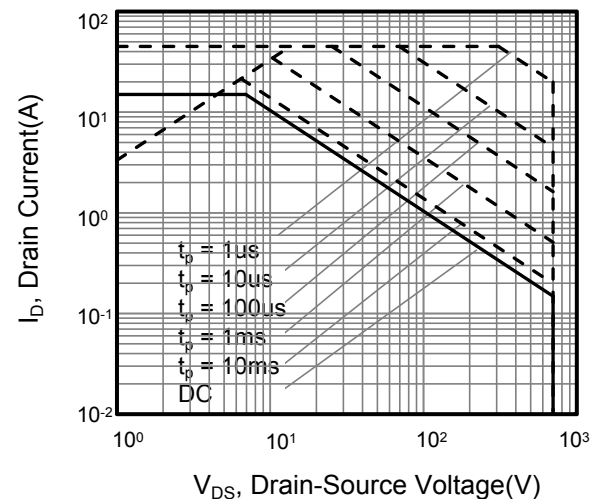

Figure 12. Safe Operation Area For TO-247





Typical Characteristics $T_J = 25^{\circ}\text{C}$, unless otherwise noted

Figure 13. Typ. Coss Stored Energy

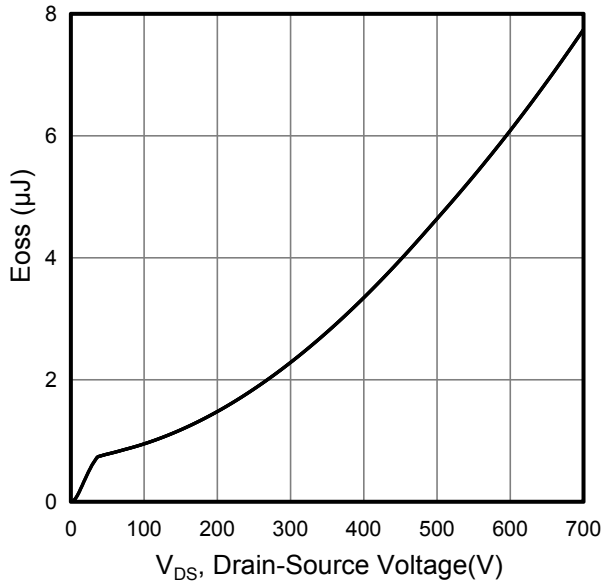



Figure A: Gate Charge Test Circuit and Waveform

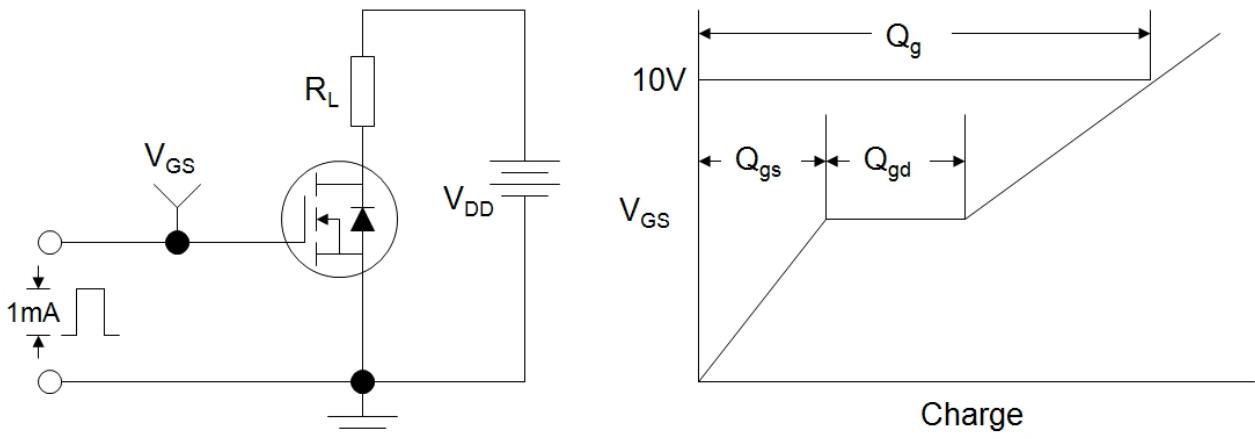

Figure B: Resistive Switching Test Circuit and Waveform

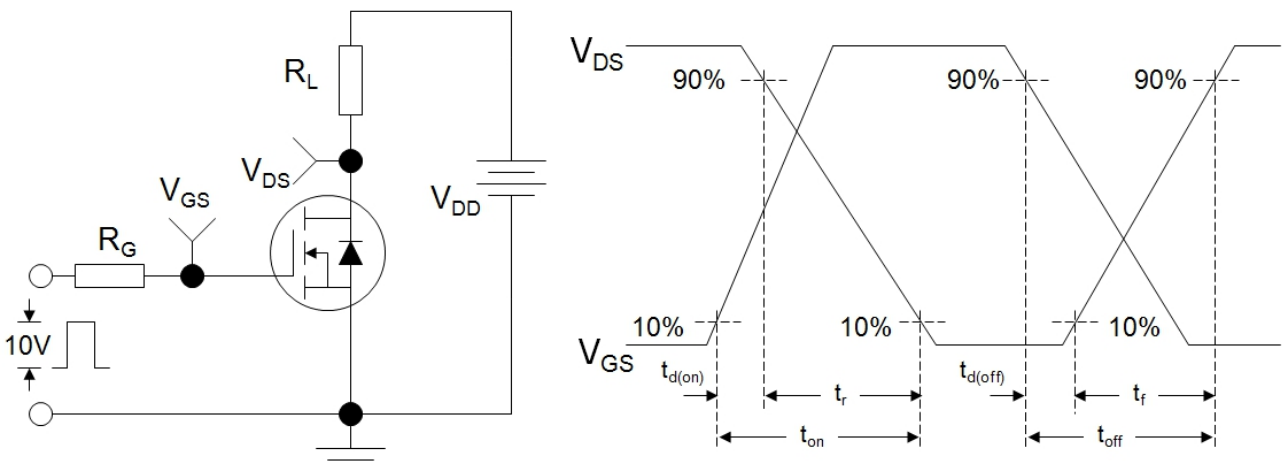
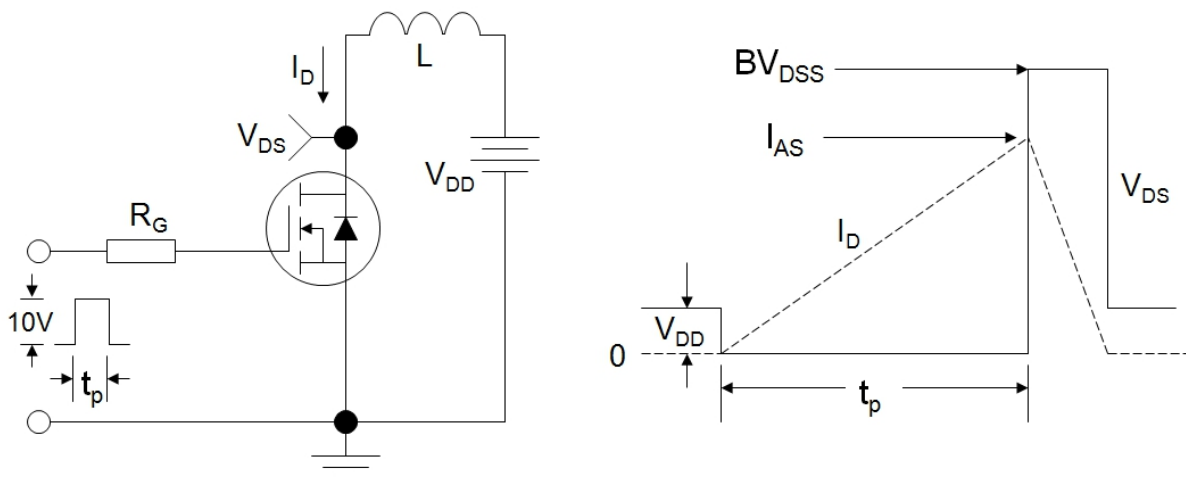
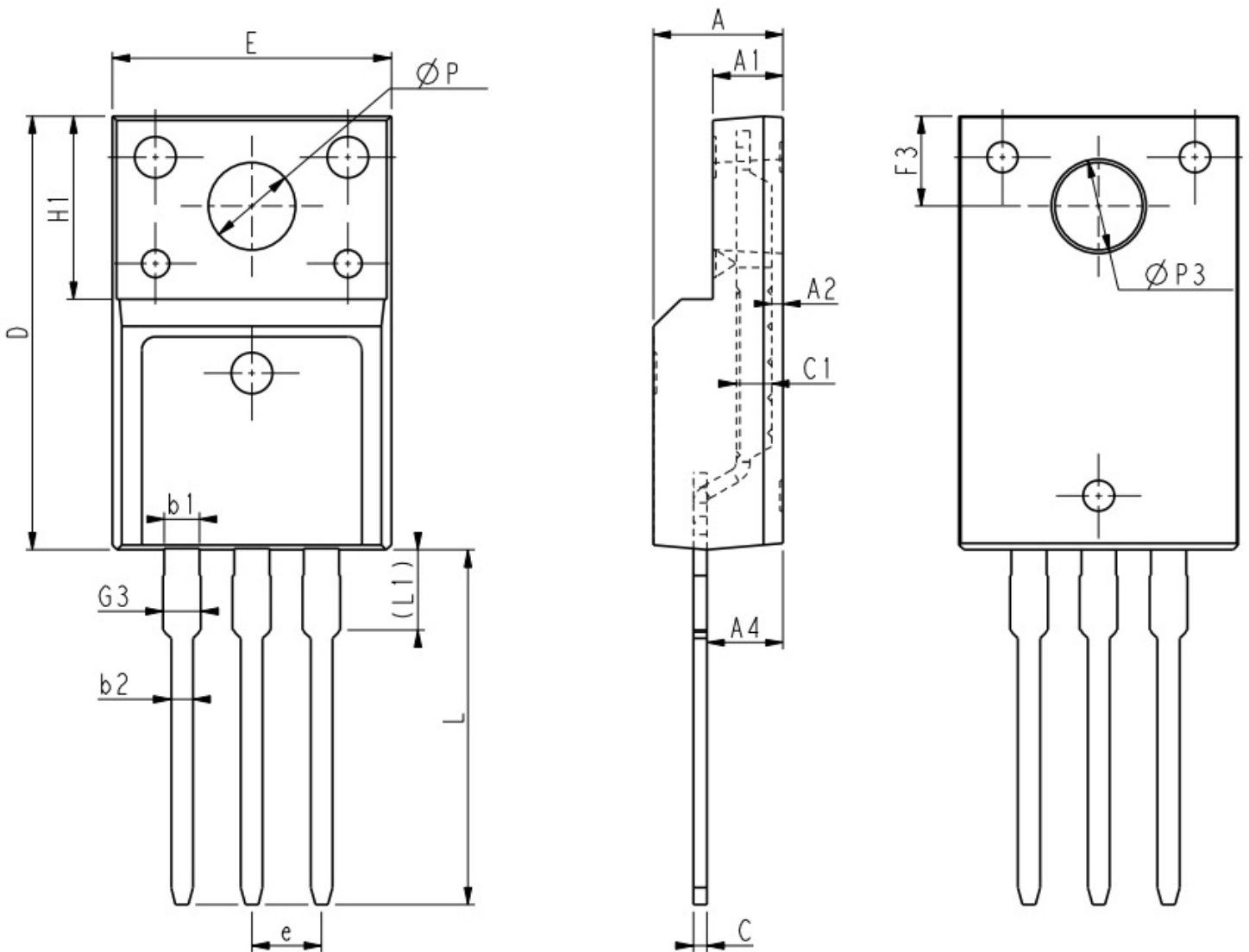

Figure C: Unclamped Inductive Switching Test Circuit and Waveform





TO-220F (封装厂 H)



Unit:mm			
Symbol	Min.	Nom	Max.
E	9.96	10.16	10.36
A	4.50	4.70	4.90
A1	2.34	2.54	2.74
A2	0.30	0.45	0.60
A4	2.56	2.76	2.96
c	0.40	0.50	0.65
c1	1.20	1.30	1.35
D	15.57	15.87	16.17
H1	6.70REF		

Unit:mm			
Symbol	Min.	Nom	Max.
e	2.54BSC		
L	12.68	12.98	13.28
L1	2.93	3.03	3.13
ΦP	3.03	3.18	3.38
ΦP3	3.15	3.45	3.65
F3	3.15	3.30	3.45
G3	1.25	1.35	1.55
b1	1.18	1.28	1.43
b2	0.70	0.80	0.95



TO-247 (封装厂 I)

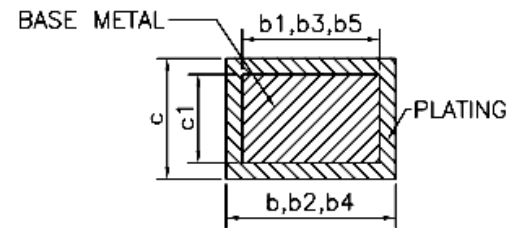
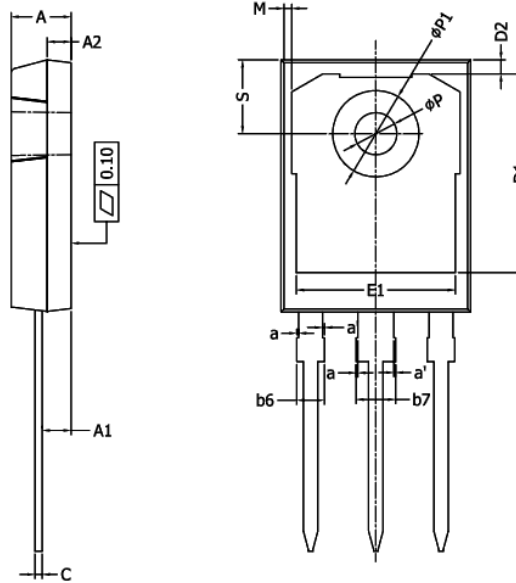
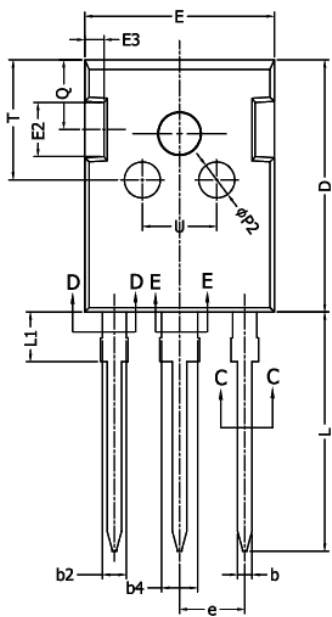

SYMBOL	MIN	NOM	MAX
A	4.90	5.00	5.10
A1	2.31	2.41	2.51
A2	1.90	2.00	2.10
a	0	---	0.15
a'	0	---	0.15
b	1.16	---	1.26
b1	1.15	1.2	1.22
b2	1.96	---	2.06
b3	1.95	2.00	2.02
b4	2.96	---	3.06
b5	2.96	3.00	3.02
b6	---	---	2.25
b7	---	---	3.25
c	0.59	---	0.66
c1	0.58	0.60	0.62
D	20.90	21.00	21.10
D1	16.25	16.55	16.85
D2	1.05	1.17	1.35
E	15.70	15.80	15.90
E1	13.10	13.30	13.50
E2	4.40	4.50	4.60
E3	2.40	2.50	2.60
e	5.436 BSC		
L	19.80	19.92	20.10
L1	---	---	4.30
M	0.35	---	0.95
P	3.40	3.50	3.60
P1	7.00	---	7.40
P2	2.40	2.50	2.60
Q	5.60	---	6.00
S	6.05	6.15	6.25
T	9.80	---	10.20
U	6.00	---	6.40



TO-247 (封装厂 E)

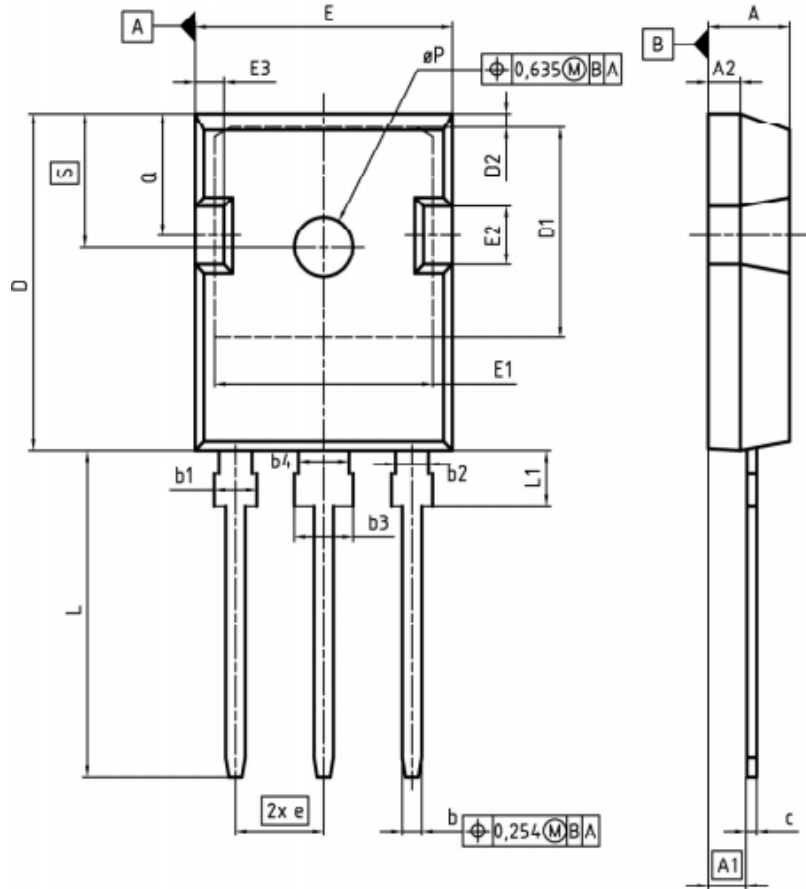

DIM	MILLIMETERS		INCHES	
	MIN	MAX	MIN	MAX
A	4.83	5.21	0.190	0.205
A1	2.27	2.54	0.089	0.100
A2	1.85	2.16	0.073	0.085
b	1.07	1.33	0.042	0.052
b1	1.90	2.41	0.075	0.095
b2	1.90	2.16	0.075	0.085
b3	2.87	3.38	0.113	0.133
b4	2.87	3.13	0.113	0.123
c	0.55	0.68	0.022	0.027
D	20.80	21.10	0.819	0.831
D1	16.25	17.65	0.640	0.695
D2	0.95	1.35	0.037	0.053
E	15.70	16.13	0.618	0.635
E1	13.10	14.15	0.516	0.557
E2	3.68	5.10	0.145	0.201
E3	1.00	2.60	0.039	0.102
e	5.44 (BSC)		0.214 (BSC)	
N	3		3	
L	19.80	20.32	0.780	0.800
L1	4.10	4.47	0.161	0.176
ϕP	3.50	3.70	0.138	0.146
Q	5.49	6.00	0.216	0.236
S	6.04	6.30	0.238	0.248



Disclaimer

All product specifications and data are subject to change without notice.

For documents and material available from this datasheet, Wuxi Unigroup does not warrant or assume any legal liability or responsibility for the accuracy, completeness of any product or technology disclosed hereunder.

No license, express or implied, by estoppels or otherwise, to any intellectual property rights is granted by this document or by any conduct of Wuxi Unigroup.

The products shown herein are not designed for use in medical, life-saving, or life-sustaining applications. Customers using or selling Wuxi Unigroup products not expressly indicated for use in such applications do so entirely at their own risk and agree to fully indemnify Wuxi Unigroup for any damages arising or resulting from such use or sale.

Wuxi Unigroup disclaims any and all liability arising out of the use or application of any product described herein or of any information provided herein to the maximum extent permitted by law. The product specifications do not expand or otherwise modify Wuxi Unigroup's terms and conditions of purchase, including but not limited to the warranty expressed therein, which apply to these products.

Wuxi Unigroup Microelectronics CO., LTD. strives to supply high-quality high-reliability products. However, any and all semiconductor products fail with some probability. It is possible that these probabilistic failures could give rise to accidents or events that could endanger human lives that could give rise to smoke or fire, or that could cause damage to other property. When designing equipment, adopt safety measures so that these kinds of accidents or events cannot occur. Such measures include but are not limited to protective circuits and error prevention circuits for safe design, redundant design, and structural design.

In the event that any or all Wuxi Unigroup products (including technical data, services) described or contained herein are controlled under any of applicable local export control laws and regulations, such products must not be exported without obtaining the export license from the authorities concerned in accordance with the above law.

Information (including circuit diagrams and circuit parameters) herein is for example only. It is not guaranteed for volume production. Wuxi Unigroup believes information herein is accurate and reliable, but no guarantees are made or implied regarding its use or any infringements of intellectual property rights or other rights of third parties.