



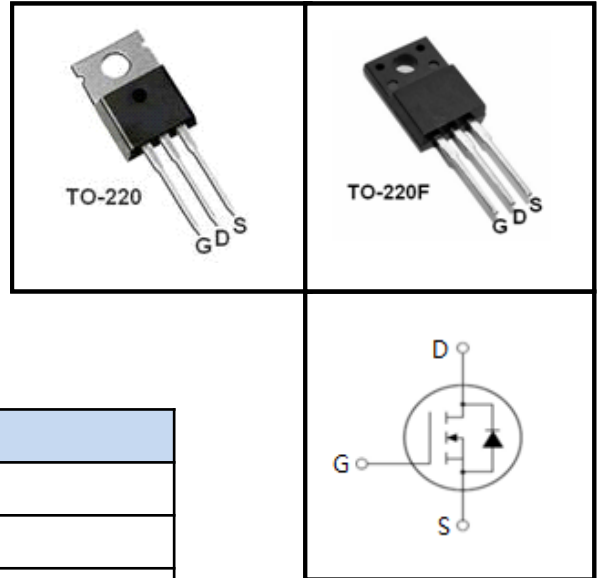
650V Super-Junction Power MOSFET

FEATURES

- Very low FOM $R_{DS(on)} \times Q_g$
- 100% avalanche tested
- RoHS compliant

APPLICATIONS

- Switch Mode Power Supply (SMPS)
- Uninterruptible Power Supply (UPS)
- Power Factor Correction (PFC)



Device Marking and Package Information		
Device	Package	Marking
TPP65R380A	TO-220	65R380A
TPA65R380A	TO-220F	65R380A

Absolute Maximum Ratings $T_C = 25^\circ\text{C}$, unless otherwise noted				
Parameter	Symbol	Value		Unit
		TO-220	TO-220F	
Drain-Source Voltage ($V_{GS} = 0\text{V}$)	V_{DSS}	650		V
Continuous Drain Current	I_D	11		A
Pulsed Drain Current (note1)	I_{DM}	33		A
Gate-Source Voltage	V_{GSS}	± 30		V
Single Pulse Avalanche Energy (note2)	E_{AS}	200		mJ
Avalanche Current (note1)	I_{AR}	11		A
Repetitive Avalanche Energy (note1)	E_{AR}	0.6		mJ
Power Dissipation ($T_C = 25^\circ\text{C}$)	P_D	125	33	W
Operating Junction and Storage Temperature Range	T_J, T_{stg}	-55~+150		$^\circ\text{C}$

Thermal Resistance				
Parameter	Symbol	Value		Unit
		TO-220	TO-220F	
Thermal Resistance, Junction-to-Case	R_{thJC}	1	3.8	$^\circ\text{C/W}$
Thermal Resistance, Junction-to-Ambient	R_{thJA}	62	80	



Specifications $T_J = 25^\circ\text{C}$, unless otherwise noted						
Parameter	Symbol	Test Conditions	Value			Unit
			Min.	Typ.	Max.	
Static						
Drain-Source Breakdown Voltage	$V_{(BR)DSS}$	$V_{GS} = 0V, I_D = 250\mu A$	650	--	--	V
Zero Gate Voltage Drain Current	I_{DSS}	$V_{DS} = 650V, V_{GS} = 0V, T_J = 25^\circ\text{C}$	--	--	1	μA
		$V_{DS} = 650V, V_{GS} = 0V, T_J = 150^\circ\text{C}$	--	--	100	
Gate-Source Leakage	I_{GSS}	$V_{GS} = \pm 30V$	--	--	± 100	nA
Gate-Source Threshold Voltage	$V_{GS(th)}$	$V_{DS} = V_{GS}, I_D = 250\mu A$	2.5	--	3.5	V
Drain-Source On-Resistance (Note3)	$R_{DS(on)}$	$V_{GS} = 10V, I_D = 6A$	--	0.34	0.38	Ω
Forward Transconductance (Note3)	g_{fs}	$V_{DS} = 10V, I_D = 11A$	--	10	--	S
Dynamic						
Input Capacitance	C_{iss}	$V_{GS} = 0V,$ $V_{DS} = 50V,$ $f = 1.0\text{MHz}$	--	1340	--	μF
Output Capacitance	C_{oss}		--	215	--	
Reverse Transfer Capacitance	C_{rss}		--	6	--	
Total Gate Charge	Q_g	$V_{DD} = 480V, I_D = 11A,$ $V_{GS} = 10V$	--	32	--	nC
Gate-Source Charge	Q_{gs}		--	8	--	
Gate-Drain Charge	Q_{gd}		--	12	--	
Turn-on Delay Time	$t_{d(on)}$	$V_{DD} = 300V, I_D = 11A,$ $R_G = 25\Omega$	--	27	64	ns
Turn-on Rise Time	t_r		--	78	164	
Turn-off Delay Time	$t_{d(off)}$		--	95	200	
Turn-off Fall Time	t_f		--	45	96	
Drain-Source Body Diode Characteristics						
Continuous Body Diode Current	I_S	$T_C = 25^\circ\text{C}$	--	--	11	A
Pulsed Diode Forward Current	I_{SM}		--	--	33	
Body Diode Voltage	V_{SD}	$T_J = 25^\circ\text{C}, I_{SD} = 11A, V_{GS} = 0V$	--	0.95	1.2	V
Reverse Recovery Time	t_{rr}	$V_R = 480V, I_F = I_S,$ $di_F/dt = 100A/\mu s$	--	360	--	ns
Reverse Recovery Charge	Q_{rr}		--	3.5	--	μC
Peak Reverse Recovery Current	I_{rrm}		--	20	--	A

Notes

1. Repetitive Rating: Pulse width limited by maximum junction temperature
2. $I_{AS} = 6A, V_{DD} = 50V, R_G = 25\Omega$, Starting $T_J = 25^\circ\text{C}$
3. Pulse Test: Pulse width $\leq 300\mu s$, Duty Cycle $\leq 1\%$



Typical Characteristics $T_J = 25^\circ\text{C}$, unless otherwise noted

Figure 1. Output Characteristics

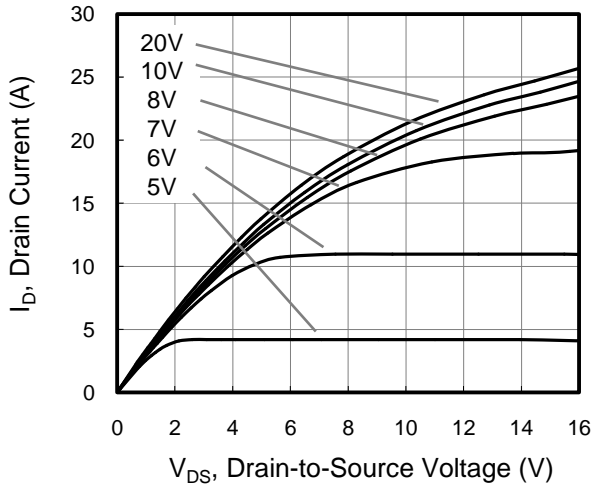


Figure 2. Transfer Characteristics

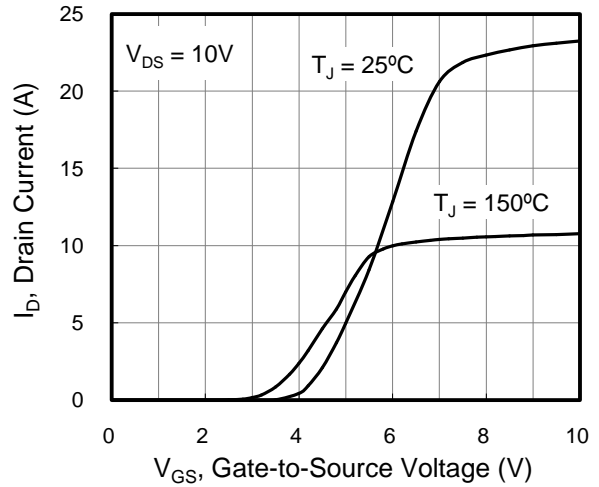


Figure 3. On-Resistance vs. Drain Current

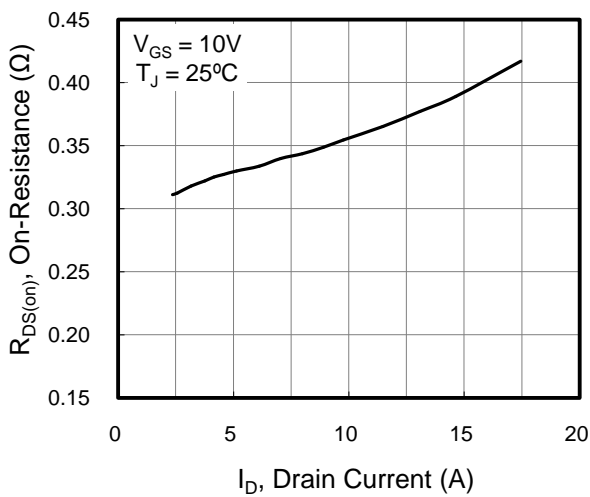


Figure 4. Capacitance

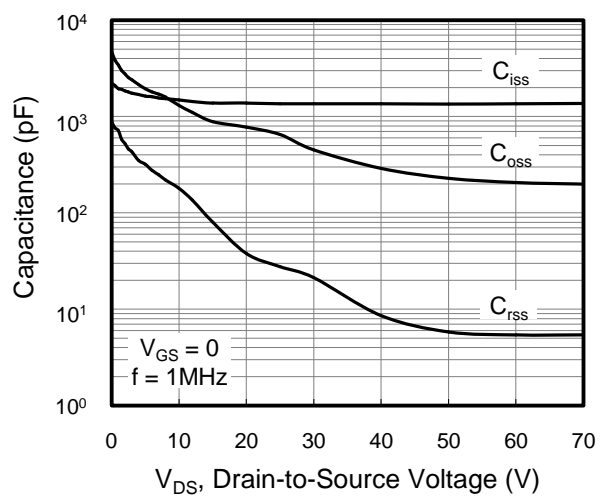


Figure 5. Gate Charge

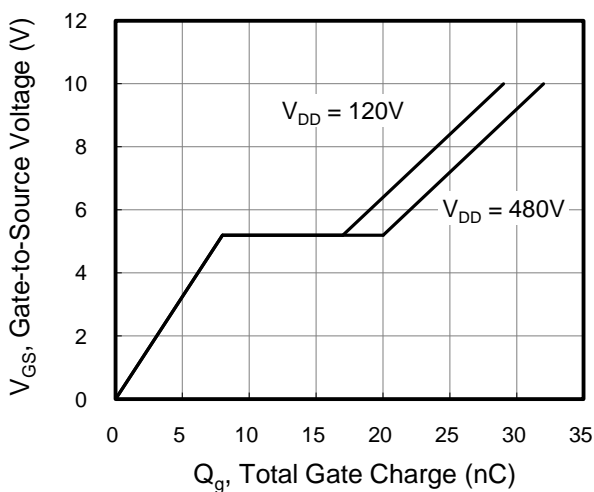
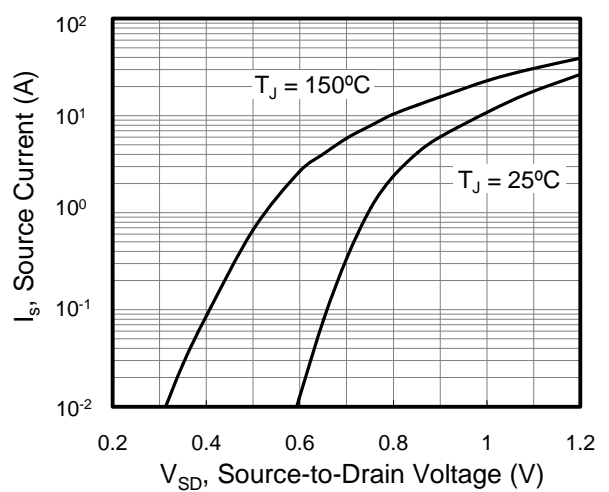


Figure 6. Body Diode Forward Voltage





Typical Characteristics $T_J = 25^\circ\text{C}$, unless otherwise noted

Figure 7. On-Resistance vs. Junction Temperature

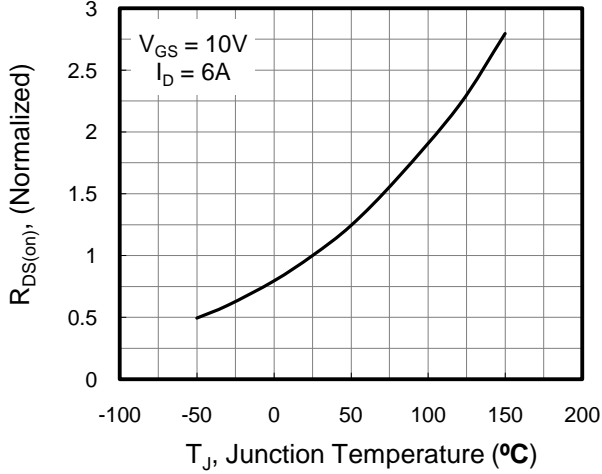


Figure 8. Threshold Voltage vs. Junction Temperature

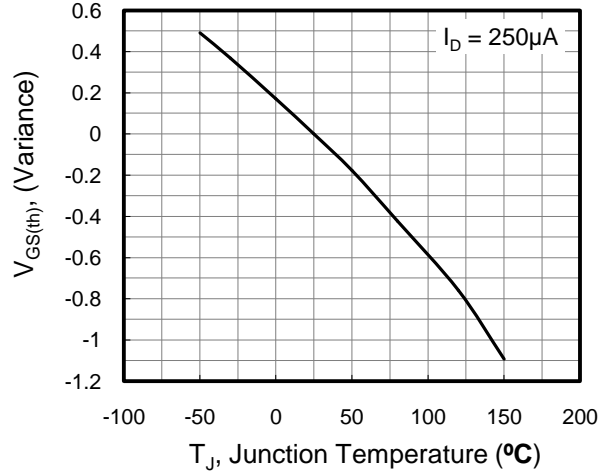


Figure 9. Transient Thermal Impedance TO-220

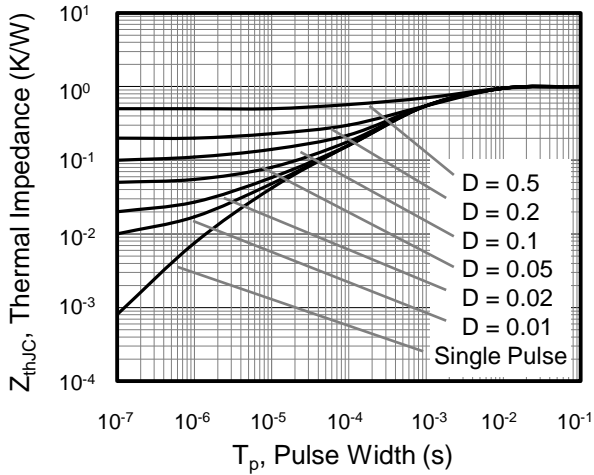


Figure 10. Transient Thermal Impedance TO-220F

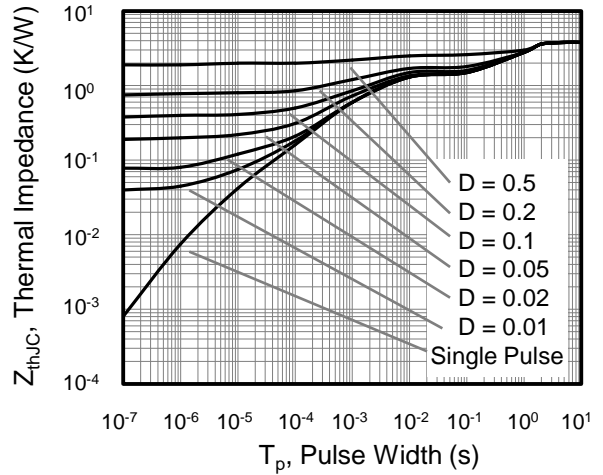


Figure 11. Safe Operating Area TO-220

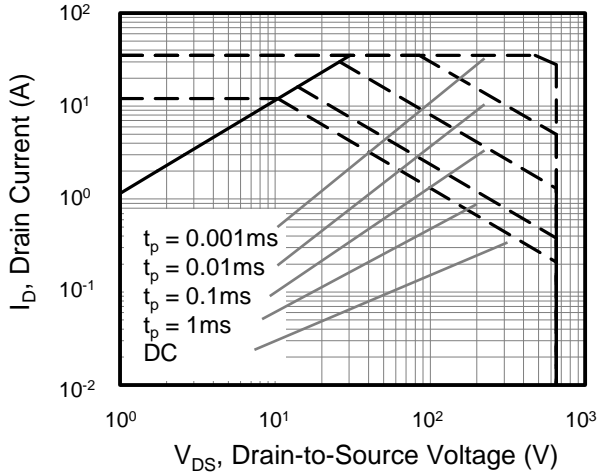


Figure 12. Safe Operating Area TO-220F

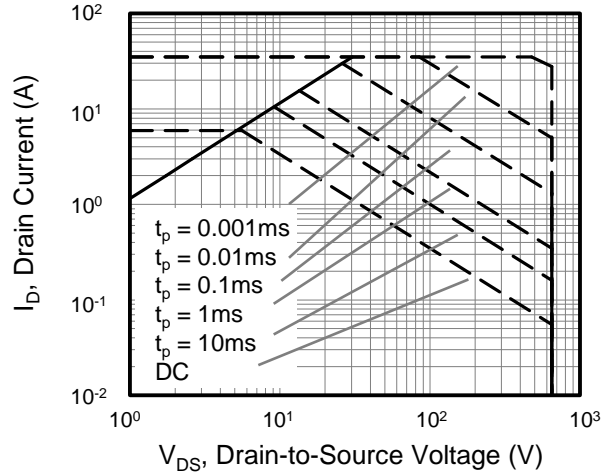




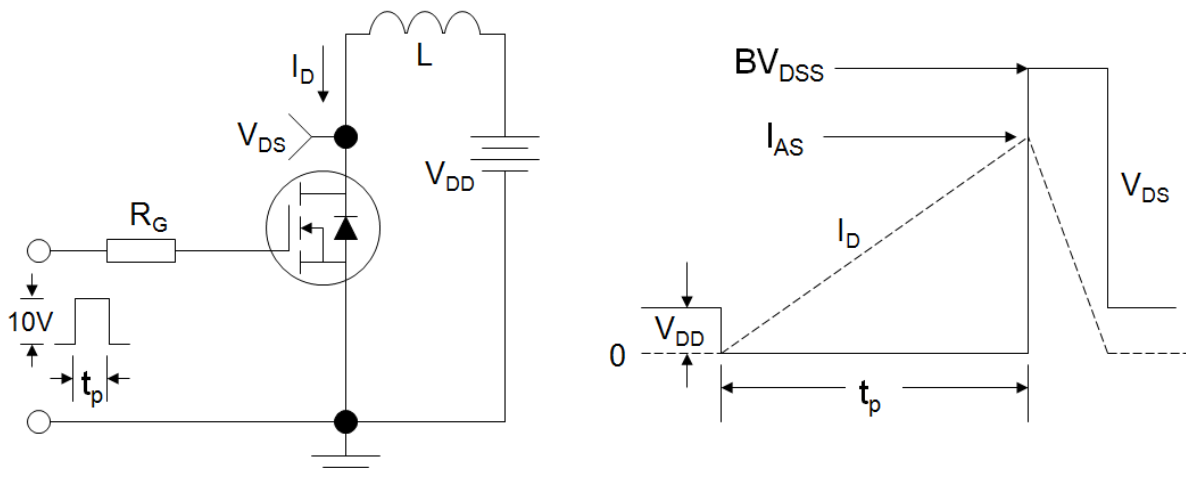
Figure A: Gate Charge Test Circuit and Waveform



Figure B: Resistive Switching Test Circuit and Waveform

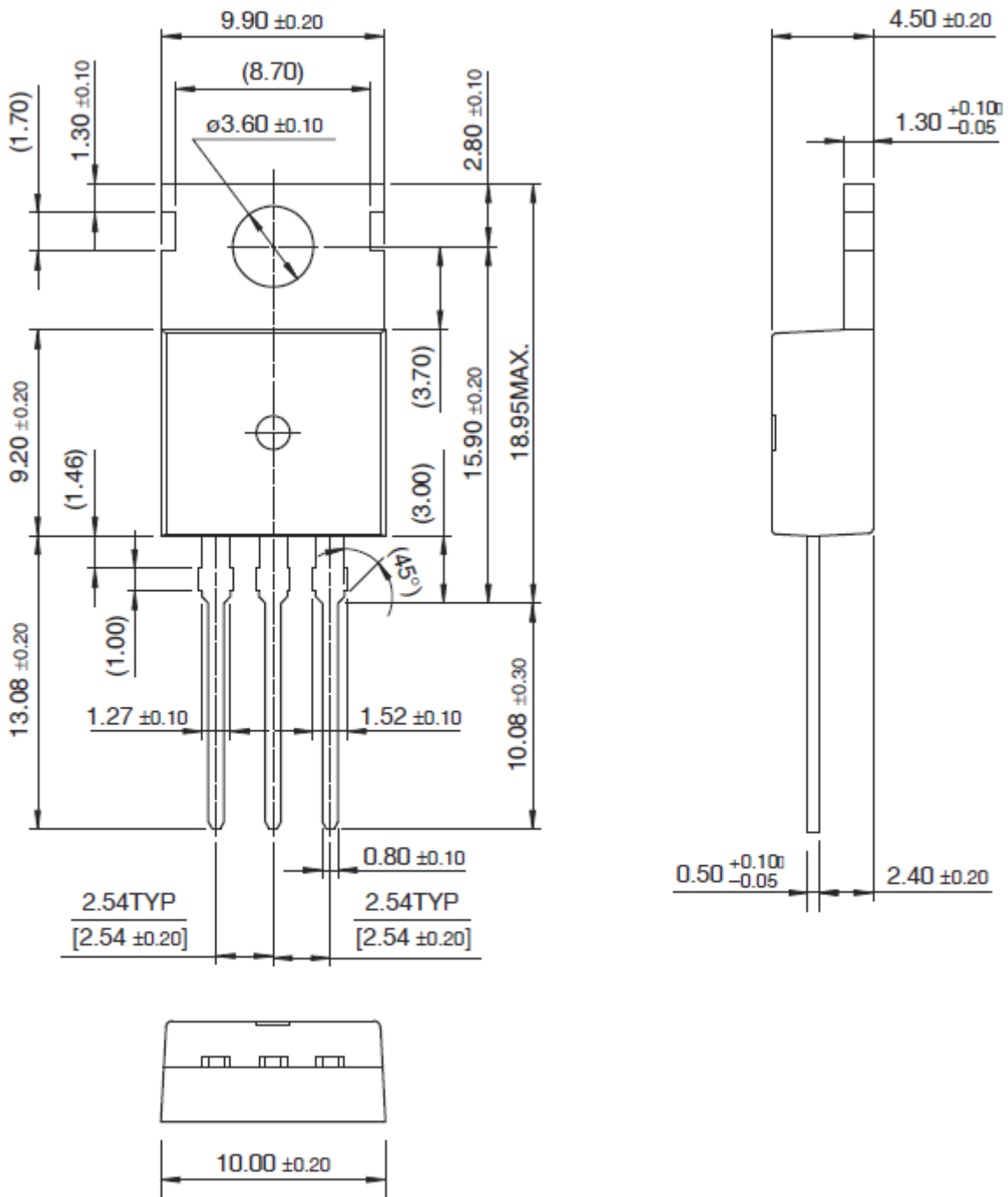


Figure C: Unclamped Inductive Switching Test Circuit and Waveform



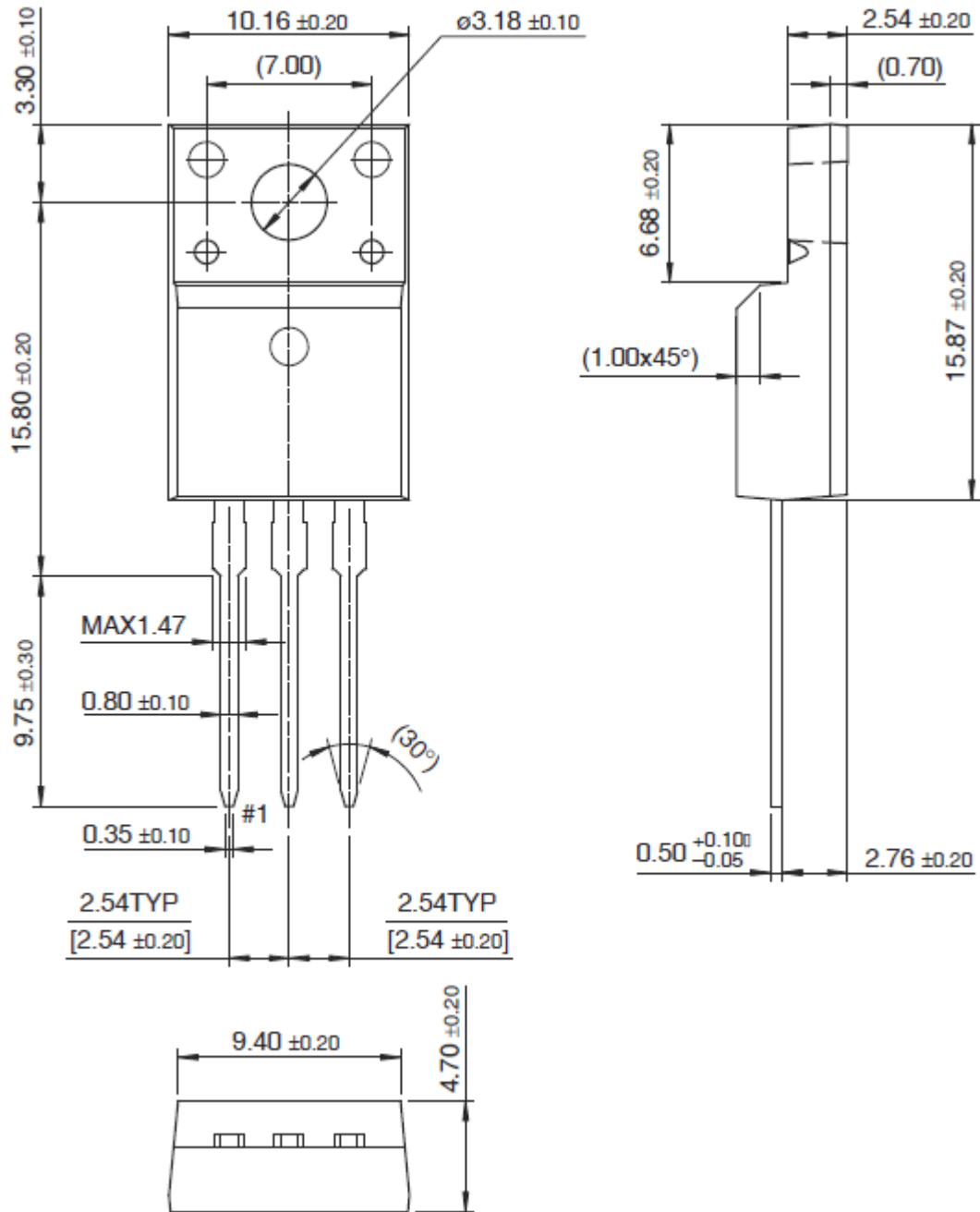


TO-220





TO-220F





Disclaimer

All product specifications and data are subject to change without notice.

For documents and material available from this datasheet, Wuxi Tongfang does not warrant or assume any legal liability or responsibility for the accuracy, completeness of any product or technology disclosed hereunder.

No license, express or implied, by estoppels or otherwise, to any intellectual property rights is granted by this document or by any conduct of Wuxi Tongfang.

The products shown herein are not designed for use in medical, life-saving, or life-sustaining applications unless. Customers using or selling Wuxi Tongfang products not expressly indicated for use in such applications do so entirely at their own risk and agree to fully indemnify Wuxi Tongfang for any damages arising or resulting from such use or sale.

Wuxi Tongfang disclaims any and all liability arising out of the use or application of any product described herein or of any information provided herein to the maximum extent permitted by law. The product specifications do not expand or otherwise modify Wuxi Tongfang's terms and conditions of purchase, including but not limited to the warranty expressed therein, which apply to these products.

Wuxi Tongfang Microelectronics CO., LTD. strives to supply high-quality high-reliability products. However, any and all semiconductor products fail with some probability. It is possible that these probabilistic failures could give rise to accidents or events that could endanger human lives that could give rise to smoke or fire, or that could cause damage to other property. When designing equipment, adopt safety measures so that these kinds of accidents or events cannot occur. Such measures include but are not limited to protective circuits and error prevention circuits for safe design, redundant design, and structural design.

In the event that any or all Wuxi Tongfang products(including technical data, services) described or contained herein are controlled under any of applicable local export control laws and regulations, such products must not be exported without obtaining the export license from the authorities concerned in accordance with the above law.

Information (including circuit diagrams and circuit parameters) herein is for example only; it is not guaranteed for volume production. Wuxi Tongfang believes information herein is accurate and reliable, but no guarantees are made or implied regarding its use or any infringements of intellectual property rights or other rights of third parties.